

PS5R-V Switching Power Supplies

Space-saving DIN-rail switching power supplies

- Spring-up terminal accepts wiring of ring terminals.
- Slim size
Width: 22.5mm (10W/15W/30W), 36mm (60W/90W), 46mm (120W), 60mm (240W)
- Can be installed in six mounting directions.
- Optional mounting bracket is available for panel mounting.
- CE marked (LVD, EMCD, RoHS)
- UL (UL508, UL1310 Class 2*1, ANSI/ISA 12.12.01)
c-UL (CSA C22.2 No. 107.1, 213, 223*1)
TÜV SÜD (EN60950-1, EN50178)
- EN61204-3 (Electromagnetic compatibility Class B)
- Meets SEMI F47 Sag Immunity (208V AC input)
- RoHS compliant
- Five-year warranty



Applicable Standards	Mark	File No. or Organization
UL508, UL1310*1 ANSI/ISA 12.12.01 CSA C22.2 No.107.1 CSA C22.2 No.213 CSA C22.2 No.223*1		UL/c-UL Listed File No. E177168 File No. E467154
EN60950-1 EN50178 EN61204-3 EN50581		TÜV SÜD*2 EU Low Voltage Directive EMC Directive RoHS Directive
SEMI F47	—	EPRI

*1: PS5R-VB/VC/VD/VE only

*2: EN60950-1, EN50178 only

PS5R-V

Package Quantity: 1

Output Capacity	Part No.	Input Voltage	Output Voltage	Output Current
10W	PS5R-VB05	100 to 240V AC (Voltage range: 85 to 264V AC / 100 to 370V DC)	5V	2.0A
15W	PS5R-VB12		12V	1.3A
	PS5R-VB24		24V	0.65A
30W	PS5R-VC12		12V	2.5A
	PS5R-VC24		24V	1.3A
60W	PS5R-VD24		24V	2.5A
90W	PS5R-VE24		24V	3.75A
120W	PS5R-VF24		24V	5.0A
240W	PS5R-VG24		24V	10.0A

DIN Rail (35mm-wide)

Length	Part No.	Material	Weight	Package Quantity
1000mm	BAA1000PN10	Aluminum	200g	10
	BAP1000PN10	Steel	320g	

End Clip

Part No.	Package Quantity
BNL6PN10	10

Panel Mounting Bracket*3

Applicable Switching Power Supply	Ordering No.	Remarks
PS5R-VB	PS9Z-5R1B	—
PS5R-VC	PS9Z-5R2B	For side mounting
PS5R-VD	PS9Z-5R1C	—
PS5R-VE	PS9Z-5R1E	—
PS5R-VF	PS9Z-6R1F	—
PS5R-VG	PS9Z-6R2F	For side mounting

*3: Used for direct panel mounting.

Part No. Development

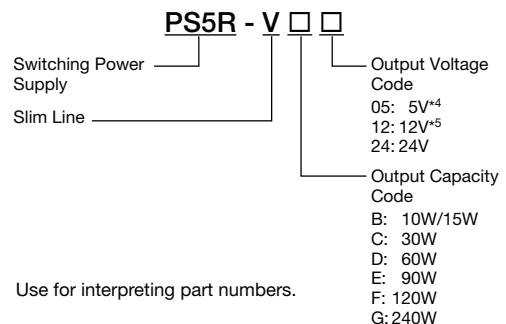

*4: PS5R-VB only

*5: PS5R-VB/VC only

PS5R-V Switching Power Supplies

Specifications

Part No.	(10W/15W) PS5R-VB05 PS5R-VB12 PS5R-VB24	(30W) PS5R-VC12 PS5R-VC24	(60W) PS5R-VD24	(90W) PS5R-VE24	(120W) PS5R-VF24	(240W) PS5R-VF24	
Rated Input Voltage (Single-phase two-wire)*1	100 to 240V AC (Voltage range: 85 to 264V AC/100 to 370V DC) (Load ≤ 80% at 100-105V DC)						
Frequency	50/60 Hz						
Input Current (Typ.)	100V AC	5V: 0.25A 12V, 24V: 0.35A	0.7A	1.3A	1.1A	1.4A	2.7A
	230V AC	5V: 0.14A 12V, 24V: 0.19A	0.3A	0.8A	0.6A	0.7A	1.2A
Inrush Current (Typ.)	100V AC	18A (Ta = 25°C, cold start)				10A max. (Ta = 25°C, cold start)	
	230V AC	45A (Ta = 25°C, cold start)				30A max. (Ta = 25°C, cold start)	
Leakage Current	120V AC	0.5 mA max.					
	230V AC	1.0 mA max.					
Efficiency (Typ.) (at rated output)*2	100V AC	5V: 77%, 12V: 82%, 24V: 84%	12V: 83%, 24V: 85%	86%	88%		
	230V AC	5V: 73%, 12V: 80%, 24V: 81%	12V: 85%, 24V: 87%	86%	89%		
Power Factor (Typ.)	100V AC	—			0.99		
	230V AC	—			0.86	0.92	0.95
Rated Voltage/Current	5V/2.0A*3, 12V/1.3A, 24V/0.65A		12V/2.5A, 24V/1.3A	24V/2.5A	24V/3.75A	24V/5A	24V/10A
Adjustable Voltage Range	±10%				±5%		±10%
Output Holding Time (Typ.) (at rated output)	100V AC	5V: 53ms, 12V: 34ms, 24V: 36ms	12V: 13ms, 24V: 15ms	13ms	20ms	30ms	30ms
	230V AC	5V: 330ms 12V: 215ms 24V: 230ms	12V: 110ms 24V: 110ms	105ms	30ms	33ms	40ms
Start Time (at rated input and output)	500 ms max.		600 ms max.	800 ms max.	700 ms max.		800 ms max.
Rise Time (at rated input and output)	5V, 12V: 200ms max. 24V: 250ms max.		200ms max.				
Regulation	Input Fluctuation		0.4% max.				
	Load Fluctuation		5V: 2.5% max. 12V, 24V: 1.0% max.	1.0% max.			
Ripple (including noise)	Temperature Change		0.05%/°C max. (-10 to +65°C)	12V: 0.05%/°C max. (-10 to +50°C) 24V: 0.05%/°C max. (-10 to +55°C)	0.05%/°C max. (-10 to +55°C)		0.05%/°C max. (-25 to +55°C)
	5V: 8% p-p max. (-25 to -10°C) 12V: 6% p-p max. (-25 to -10°C) 24V: 4% p-p max. (-25 to -10°C)		12V: 6% p-p max. (-25 to -10°C) 24V: 4% p-p max. (-25 to -10°C)	4% p-p max. (-25 to -10°C)		4% p-p max. (-25 to -10°C)	
	5V: 5% p-p max. (-10 to +0°C) 12V: 2.5% p-p max. (-10 to +0°C) 24V: 1.5% p-p max. (-10 to +0°C)		12V: 2.5% p-p max. (-10 to +0°C) 24V: 1.5% p-p max. (-10 to +0°C)	1.5% p-p max. (-10 to +0°C)		1.5% p-p max. (-10 to +0°C)	
Supplementary Functions	Overcurrent Protection		105% min. (auto reset)		101% min. (auto reset)	105% min. (auto reset)	
	Operation Indicator		LED (green)				
	Dielectric Strength		Between input and output terminals: 3,000V AC, 1 minute Between input and ground terminals: 2,000V AC, 1 minute Between output and ground terminal: 500V AC, 1 minute				
Insulation Resistance		Between input and output terminals: 100MΩ min. (500V DC megger), Between input and ground terminal: 100MΩ min. (500V DC megger)					
Operating Temperature*4		-25 to +75°C (no freezing)		-25 to +70°C (no freezing)	-25 to +65°C (no freezing)		
Operating Humidity		20 to 90% RH (no condensation)					
Storage Temperature		-25 to +75°C (no freezing)					
Storage Humidity		20 to 90% RH (no condensation)					
Vibration Resistance		10 to 55 Hz, amplitude 0.375mm, 2 hours each in 3 axes (when used with part no. BNL6 mounting clips)		10 to 55 Hz, amplitude 0.33mm, 2 hours each in 3 axes (when used with part no. BNL6 mounting clips) 10 to 55 Hz, amplitude 0.375mm, 2 hours each in 3 axes (when used with part no. BNL8 mounting clips)		10 to 55 Hz, amplitude 0.21mm, 2 hours each in 3 axes (when used with part no. BNL6 mounting clips) 10 to 55 Hz, amplitude 0.375mm, 2 hours each in 3 axes (when used with part no. BNL6 mounting clips)	
Shock Resistance		300 m/s ² , 3 times each in 6 directions					
EMC	EMI	EN61204-3 (Class B)					
	EMS	EN61204-3 (Industrial)					
Safety Standards		UL508 (Listing), UL1310 Class 2, ANSI/ISA-12.12.01, CSA C22.2 No. 107.1, 213, 223 EN60950-1, EN50178			UL508 (Listing), ANSI/ISA-12.12.01 CSA C22.2 No. 107.1, 213, EN60950-1, EN50178		
Other Standard		SEMI F47 (at 208V AC input only)					
Degree of Protection		IP20 (EN60529)					
Dimensions (mm)		90H × 22.5W × 95D		95H × 36W × 108D		115H × 46W × 121D	125H × 60W × 125D
Weight (approx.)		140g	150g	260g	310g	470g	960g
Terminal Screw		M3.5					

At normal temperature and humidity unless otherwise specified.

*1: DC input voltage is not subject to safety standards. When using on DC input, connect a fuse to the input terminal for DC input protection.

*2: Under stable state. *3: PS5R-VB05 (5V DC/2.0A) is 10W (Up to 3.0A at Ta = 0 to 40°C. Not subject to safety standards at 2.0A and over.)

*4: See the output derating curves on page 3.

Reference Value

Expected Life*5	8 years minimum (at the rated input, 50% load, operating temperature +40°C, standard mounting direction)
-----------------	--

*5: Calculation of the expected life is based on the actual life of the aluminum electrolytic capacitor. The expected life depends on operating conditions.

PS5R-V Switching Power Supplies

Characteristics

Operating Temperature vs. Output Current (Derating Curves)

Conditions: Natural air cooling (Operating temperature is the temperature around the switching power supply.)

PS5R-VB05, -VB12, -VB24

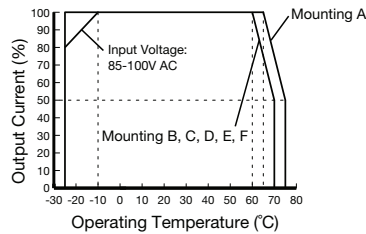

PS5R-VC12

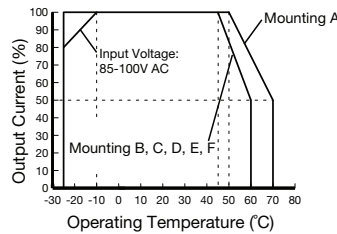

PS5R-VC24

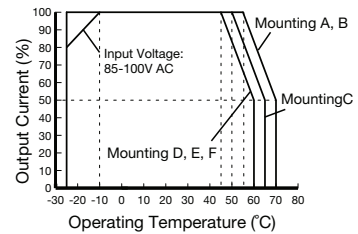

PS5R-VD24

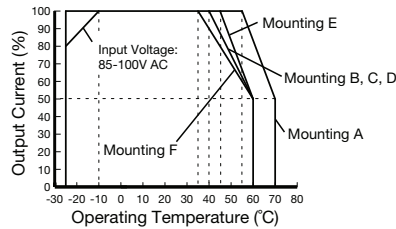

PS5R-VE24

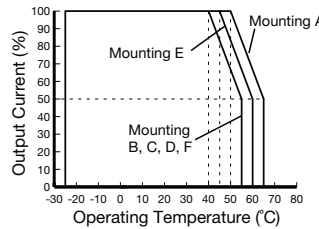

PS5R-VF24

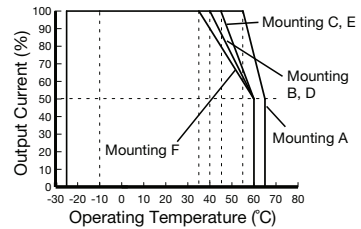

PS5R-VG24

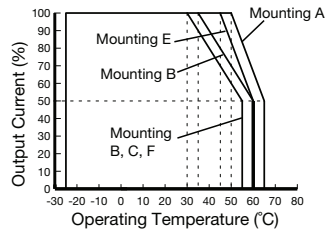

Operating Temperature Approved by Safety Standards

Part No.	UL508, CSA C22.2 No.107.1, ANSI/ISA12.12.01, EN60950-1, EN50178					
	Mounting A	Mounting B	Mounting C	Mounting D	Mounting E	Mounting F
PS5R-VB05, -VB12, -VB24	65	60	60	60	60	60
PS5R-VC12	50	45	45	45	45	45
PS5R-VC24	55	55	50	45	45	45
PS5R-VD24	55	40	40	40	45	35
PS5R-VE24	50	40	40	40	45	40
PS5R-VF24	55	40	45	40	45	35
PS5R-VG24	50	35	30	30	45	30

Mounting Style

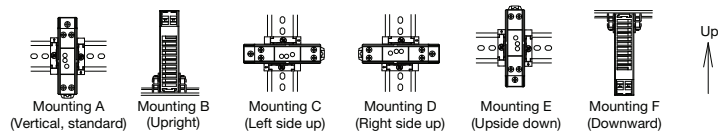

Output Current vs. Input Voltage (derating curves)

PS5R-VG24

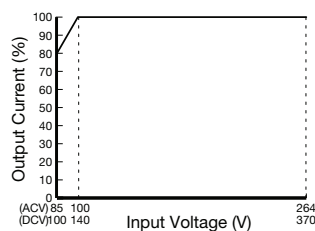

PS5R-V Switching Power Supplies

Overcurrent Protection Characteristics

PS5R-VB/VC/VD/VF

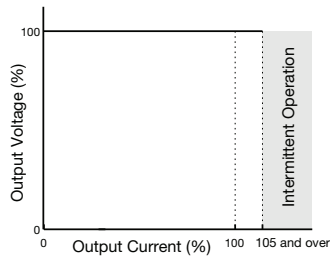

PS5R-VE24

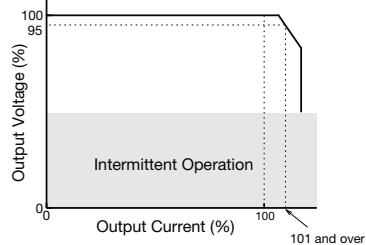

PS5R-VG24

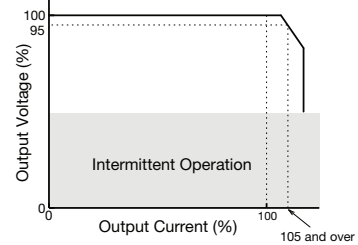

Parts Description

PS5R-VB/VC

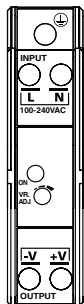

PS5R-VD/VE/VF

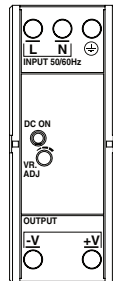

PS5R-VG

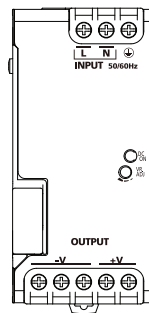

Marking	Name	Description
L, N	AC Input Terminal	Voltage range: 85 to 264V AC/100 to 370V DC
⊕	Ground Terminal	Be sure to connect this terminal to a proper ground.
+V, -V	DC Output Terminals	+V: Positive output terminal -V: Negative output terminal
VR.ADJ	Output Voltage Adjustment	Turning clockwise increases the output voltage. Turning counterclockwise decreases the output voltage.
DC ON	Operation Indicator (green)	Lights when the output voltage is on.

PS5R-V Switching Power Supplies

Dimensions

PS5R-VB/VC

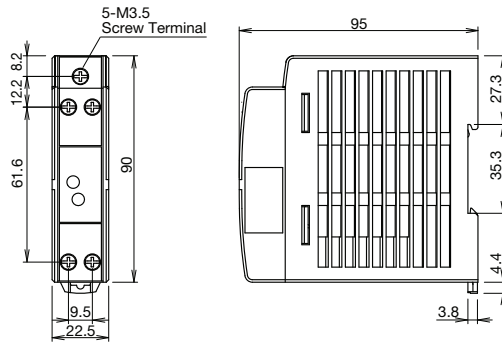

PS5R-VD/VE

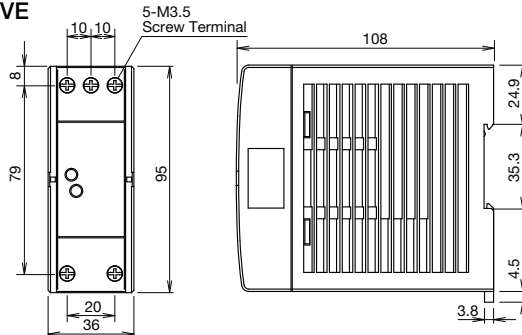

PS5R-VF

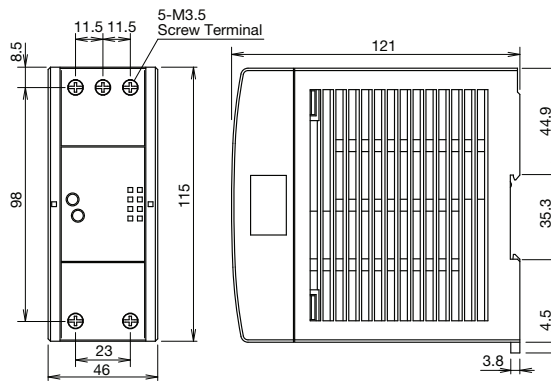

PS5R-VG

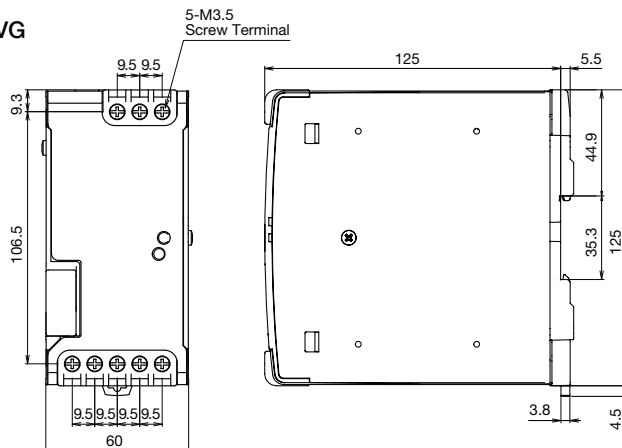

All dimensions in mm.
Tolerance: ± 1 mm

PS5R-V Switching Power Supplies

Dimensions

Panel Mounting Bracket

When installed on switching power supply

PS9Z-5R1B

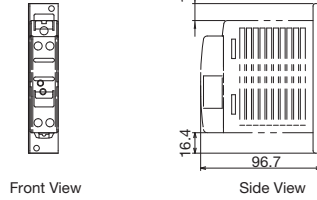
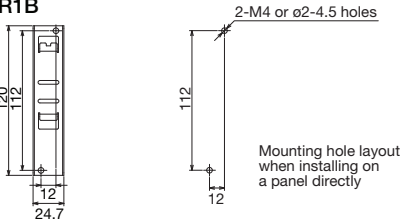

PS9Z-5R2B Side-mount

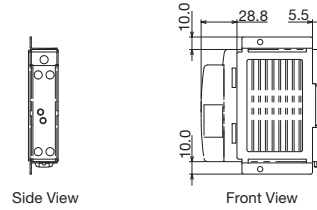
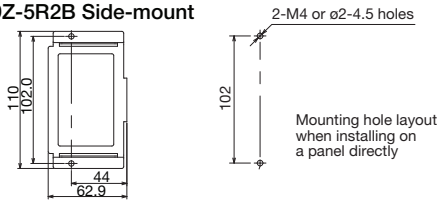

PS9Z-5R1C

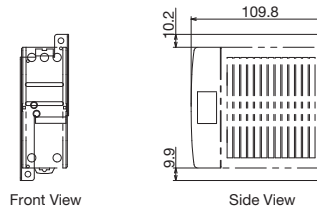
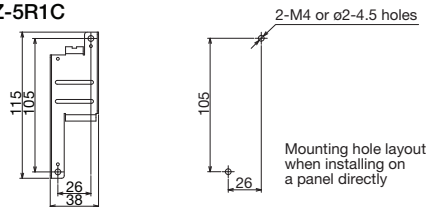

PS9Z-5R1E

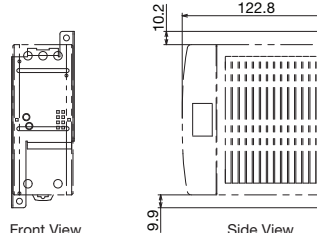
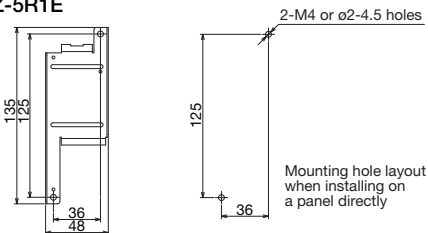

PS9Z-6R1F

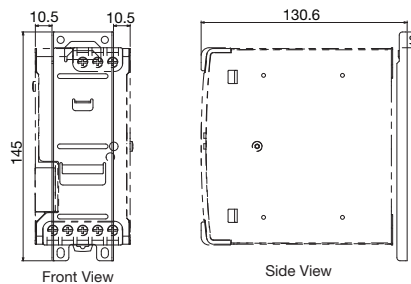
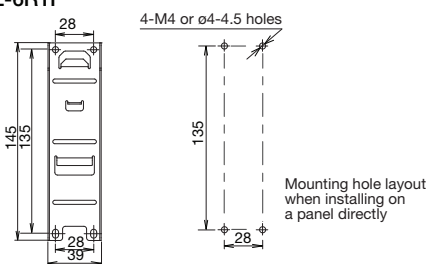

PS9Z-6R2F Side-mount

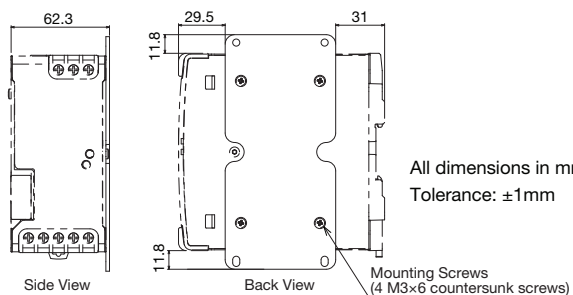
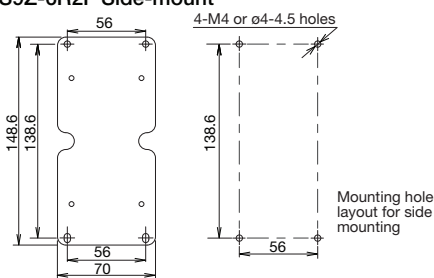

All dimensions in mm.
Tolerance: ±1mm

PS5R-V Switching Power Supplies

Safety Precautions

Mount the PS5R-V in an enclosure. Do not use the PS5R-V alone as an Electric Facilities for General Use.
Use the PS5R-V for electric facilities for business use only.

- Do not use switching power supplies with electric equipment whose malfunction or inadvertent operation may damage the human body or life directly.
- Make sure that the input voltage and output current do not exceed the ratings. If the input voltage and output current exceed the ratings, electric shock, fire, or malfunction may occur.
- Do not touch the terminals of the switching power supply while input voltage is applied, otherwise electric shock may occur.
- Provide the final product with protection against malfunction or damage that may be caused by malfunction of the switching power supply.
- Operating temperatures should not exceed the ratings. Be sure to note the derating characteristics. If the operating temperature exceeds the ratings, electric shock, fire, or malfunction may occur.
- Blown fuses indicate that the internal circuits are damaged. Contact IDEC for repair. Do not just replace the fuse and reoperate, otherwise electric shock, fire, or malfunction may occur.
- Do not use the switching power supplies to charge rechargeable batteries.
- Do not overload or short-circuit the switching power supply for a long period of time, otherwise the internal elements may be damaged.
- Do not disassemble, repair, or modify the power supplies, otherwise the high voltage internal part may cause electric shock, fire, or malfunction.
- The fuse inside the PS5R-V switching power supply is for AC input. Use a DC fuse for DC input.

Operating Instructions

Notes for installation

- Do not close the top and bottom openings of the PS5R-V to allow for heat radiation by convection.
- Maintain a minimum of 10 mm clearance around the PS5R-V, except for the top and bottom openings.
- When mounting multiple PS5R-V switching power supplies side by side, maintain a minimum of 10 mm clearance. Observe the derating curves in consideration of the ambient temperature.

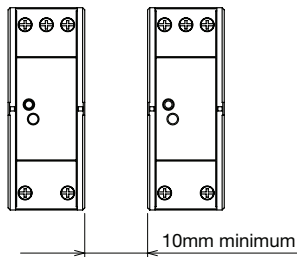

- When the derating voltage may exceed the recommended value, provide forced air-cooling.
- Make sure to wire the ground terminal correctly.
- For wiring, use wires of heat resistance of 60°C or higher (PS5R-VB: 80°C or higher). Use copper wire of the following sizes, according to the rated current.

Terminal	Wire Size (allowable current)	Wire Type
Input	AWG18 to 14	Copper Solid/Stranded
Output	AWG18 to 14 (AWG18: 7A, AWG16: 10A, AWG14: 15A)	

Cross-sectional area
AWG18: 0.82mm², AWG16: 1.31mm², AWG14: 2.0mm²

Note: Wires of the above size must be used to comply with UL508, CSA C22.2 No. 107.1.

Applicable crimp terminal (reference)

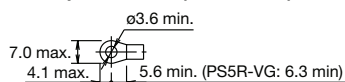

- Recommended tightening torque of the input and output terminals is 1.0 to 1.3 N·m (0.8 N·m for UL).

Mounting on DIN Rails

1. Use a 35mm-wide DIN rail.
2. Fasten the DIN rail to a mounting plate using screws.
3. Place the PS5R-V on the DIN rail as shown with input terminal side up (①), and press the PS5R-V towards the DIN rail (②). Make sure that the PS5R-V is installed firmly.
4. Use BNL6 mounting clips for fastening the PS5R-V on the DIN rail. Use of BNL8 mounting clips is recommended when excessive vibration or shock is anticipated. Do not use the PS5R-V when it is subject to vibration constantly.

Removal

- Insert a flat screwdriver into the slot in the clamp, and pull out the clamp until it clicks (③). The lock mechanism is released and the PS5R-V can be removed (④). When mounting the PS5R-V again, push in the latch first.

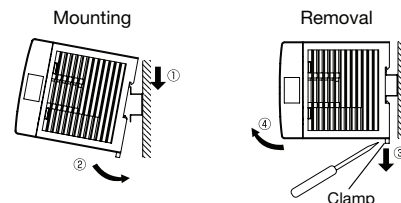

PS5R-V Switching Power Supplies

Operating Instructions

Installing the Panel Mounting Bracket

<Installing PS9Z-5R1□ Panel Mounting Bracket>

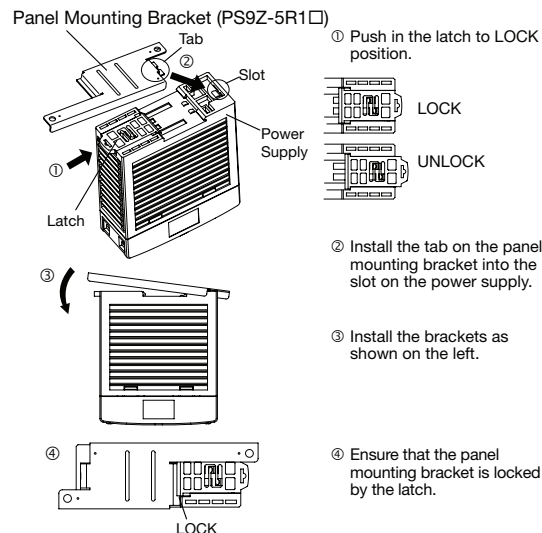

<Installing PS9Z-5R2B Panel Mounting Bracket>

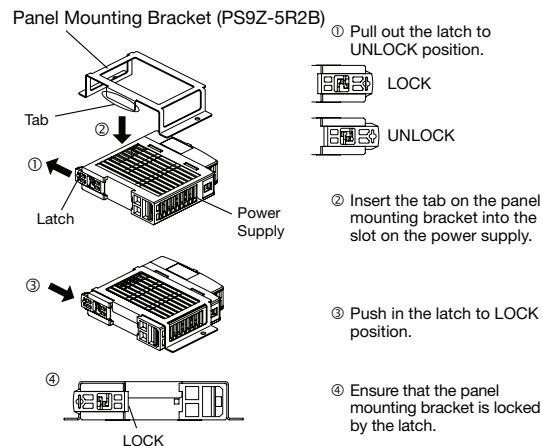

Installing PS9Z-6R2F Side-mount Panel Mounting Bracket

Install the bracket on the switching power supply using four M3 × 6 countersunk screws supplied with the bracket.

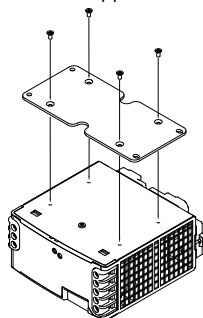

Adjustment of Output Voltage

The output voltage can be adjusted within $\pm 10\%$ of the rated output voltage (PS5R-VE: $\pm 5\%$) by using the VR.ADJ control on the front. Turning the VR.ADJ clockwise increases the output voltage. Turning the VR.ADJ counterclockwise decreases the output voltage.

Overcurrent Protection

The output voltage drops automatically when an overcurrent flows due to an overload or short circuit. Normal voltage is automatically restored when the load returns to normal conditions.

Insulation/Dielectric Test

When performing an insulation/dielectric test, short-circuit the input (between L and N) and output (between +V and -V). Do not apply or interrupt the voltage quickly, otherwise surge voltages may be generated and the PS5R-V may be damaged.

Notes for Operation

- Output interruption may indicate blown fuses. Contact IDEC.
- The PS5R-V switching power supply contains an internal fuse for AC input. When using with DC input, install an external fuse for DC input. To avoid blown fuses, select a fuse in consideration of the rated current of the internal fuse.

Rated Current of Internal Fuses

Part No.	Internal Fuse Rated Current
PS5R-VB/VC	2A
PS5R-VD/VE/VE/F	4A
PS5R-VG	6.3A

- Avoid overload and short-circuit for a long period of time, otherwise the internal elements may be damaged.
- DC input operation is not subject to safety standards.

Rust and Scratches on Metal parts

Hot-dip galvanized steel and bonderized steel are used for the PS5R-V. Rust on the edge and scratches on the surfaces may be developed depending on the storage condition, but the performance of the PS5R-V is not affected.

Noise

Small acoustic noise inside the PS5R-V may be heard depending on the input voltage and load, but the performance of the PS5R-V is not affected.

PS5R-V Switching Power Supplies

Operating Instructions

Series Operation

The following series operation is allowed. Connect Schottky barrier diodes D as shown below. DC-DC converter unit cannot be connected in series. Select a Schottky diode in consideration of the rated current. The diode's reverse voltage must be higher than the PS5R-V's output voltage.

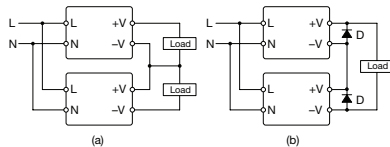

Parallel Operation

Parallel operation is not possible to increase the output capacity, because the internal elements and load may be damaged.

Backup Operation

Backup operation is a connection method of two switching power supplies in parallel for emergency. Normally one switching power supply has a sufficient output. If one switching power supply fails, another one operates to continue the output. Make sure that the sum of power consumption by load and diode is not greater than the rated wattage (rated voltage \times rated current) of one switching power supply.

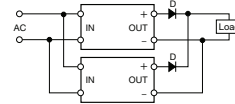

Select a diode in consideration of:

Diode's current must be more than double the PS5R-V's output current. Take heat dissipation into consideration.

Warranty

Warranty

IDEC warrants the PS5R-V switching power supplies for a period of five years from the date of shipment.

Scope

IDEC agrees to repair or replace the PS5R-V switching power supply if the product has been operated under the following conditions. The maximum value of output capacity is within the range shown in "Operating Temperature vs. Output Current" on page 3.

1. Average operating temperature (ambient temperature of switching power supply) is 40°C maximum.
2. The load is 80% maximum.
3. Input voltage is the rated input voltage.
4. Standard mounting style

IDEC shall not be liable for other damages including conse-

quential, contingent or incidental damages. Warranty does not apply if the PS5R-V switching power supply was subject to:

1. Inappropriate handling, or operation beyond the specifications.
2. Modification or repair by other than IDEC.
3. Failure caused by other than the PS5R-V switching power supply.
4. Failure caused by natural disasters.

Specifications and other descriptions in this brochure are subject to change without notice.



IDEC CORPORATION

6-64, Nishi-Miyahara 2-Chome, Yodogawa-ku, Osaka 532-0004, Japan
Tel: +81-6-6398-2527, Fax: +81-6-6398-2547
E-mail: marketing@idec.co.jp

IDEC CORPORATION (USA)
1175 Elko Drive, Sunnyvale, CA 94089-2209, USA
Tel: +1-408-747-0550 / (800) 262-IDEC (4332)
Fax: +1-408-744-9055 / (800) 635-6246
E-mail: opencontact@idec.com

IDEC CANADA LIMITED
3155 Pepper Mill Court, Unit 4
Mississauga, Ontario, L5L 4X7, Canada
Tel: +1-905-890-8561, Toll Free: (888) 317-IDEC (4332)
Fax: +1-905-890-8562
E-mail: sales@ca.idec.com

IDEC AUSTRALIA PTY. LTD.
Unit 17, 104 Ferntree Gully Road,
Oakleigh, Victoria 3166, Australia
Tel: +61-3-8523-5900, Toll Free: 1800-68-4332
Fax: +61-3-8523-5999
E-mail: sales@au.idec.com

IDEC ELEKTROTECHNIK GmbH
Heselerstruecken 8, 22453 Hamburg, Germany
Tel: +49-40-25 30 54 - 0, Fax: +49-40-25 30 54 - 24
E-mail: service@idec.de

IDEC (SHANGHAI) CORPORATION
Room 701-702 Chong Hing Finance Center,
No. 288 Nanjing Road West, Shanghai 200003, PRC
Tel: +86-21-6135-1515
Fax: +86-21-6135-6225 / +86-21-6135-6226
E-mail: idec@cn.idec.com

IDEC (BEIJING) CORPORATION
Room 211B, Tower B, The Grand Pacific Building,
8A Guanghua Road, Chaoyang District,
Beijing 100026, PRC
Tel: +86-10-6581-6131, Fax: +86-10-6581-5119

IDEC (SHENZHEN) CORPORATION
Unit AB-3B2, Tian Xiang Building, Tian'an Cyber Park,
Fu Tian District, Shenzhen, Guang Dong 518040, PRC
Tel: +86-755-8356-2977, Fax: +86-755-8356-2944

IDEC IZUMI (H.K.) CO., LTD.
Unit G & H, 26/F, MG Tower, No. 133 Hoi Bun Road,
Kwun Tong, Kowloon, Hong Kong
Tel: +852-2803-8989, Fax: +852-2565-0171
E-mail: info@hk.idec.com

IDEC TAIWAN CORPORATION
8F-1, No. 79, Hsin Tai Wu Road, Sec. 1,
Hsi-Chih District, 22101 New Taipei City, Taiwan
Tel: +886-2-2698-3929, Fax: +886-2-2698-3931
E-mail: service@tw.idec.com

IDEC IZUMI ASIA PTE. LTD.
No. 31, Tannery Lane #05-01,
HB Centre 2, Singapore 347788
Tel: +65-6746-1155, Fax: +65-6844-5995
E-mail: info@sg.idec.com

IDEC ASIA (THAILAND) CO., LTD.
20th Fl., Sorachai Bldg., No.23/78,
Soi Sukhumvit 63, Sukhumvit Rd.,
Klongton-nua, Wattana, Bangkok 10110
Tel: +662-392-9765, Fax: +662-392-9768
E-mail: sales@th.idec.com

www.idec.com

Cat. No. EP1591-0 FEBRUARY 2016 PDF